

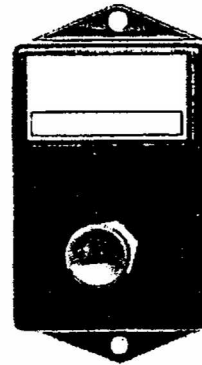

VENDING, INC.

2062 E. 70TH STREET, CLEVELAND, OH 44103  
(216) 361-1022 OR TOLL FREE (800) 445-8363

## WIRELESS REMOTE CONTROL CIGARETTE CONVERSION SYSTEM

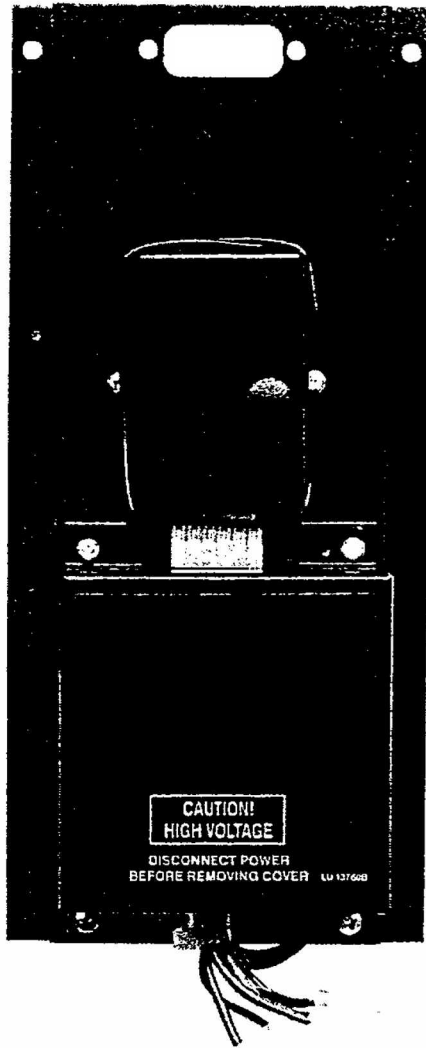

# WIRELESS REMOTE CONTROL

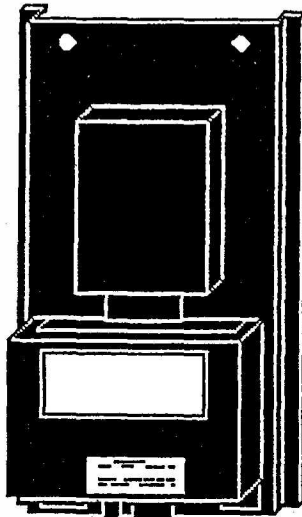

RECEIVING UNIT

**ATTENTION**  
THIS VENDING MACHINE DOES NOT DISPENSE CIGARETTES ON A SELF-SERVICE BASIS. AN EMPLOYEE MUST VERIFY THAT A PERSON DESIRING TO PURCHASE CIGARETTES FROM THIS VENDING MACHINE IS OF LEGAL AGE. THANK YOU

DECAL

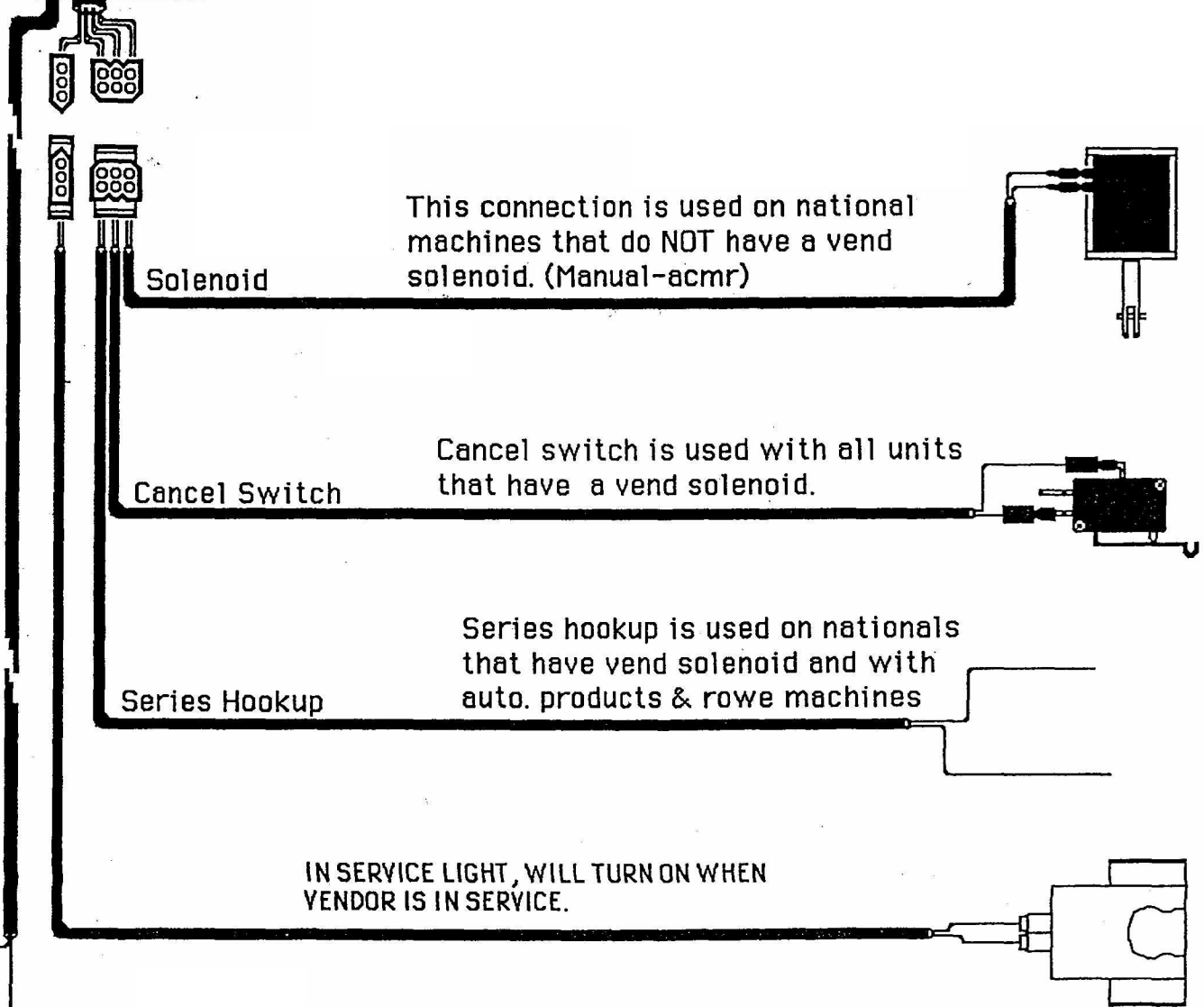

CONNECT TO 115 VOLTS AC.

# WIRELESS REMOTE CONTROL UNIT ELECTRICAL INSTALLATION

## CURRENCY PARTNER 1000:

CUT ONE WIRE GOING TO THE VEND SOLENOID. CONNECT BLACK WIRE TO ONE SIDE OF THE CUT WIRE AND CONNECT THE RED WIRE TO THE OTHER SIDE OF THE CUT WIRE.

MOUNT NEW CANCEL SWITCH ON TOP OF EXISTING CANCEL SWITCH. CONNECT WIRES TO THE (NC) NORMALLY CLOSED AND (C) COMMON TERMINALS OF THE NEW CANCEL SWITCH.

WITH THIS INSTALLATION THE CUSTOMER CAN INSERT MONEY BUT WILL NOT BE ABLE TO MAKE A SELECTION UNTIL THE REMOTE CONTROL IS ACTUATED. WHEN THE REMOTE CONTROL IS ON, THE CIRCUIT TO THE VEND SOLENOIDS WILL BE COMPLETED AND A SELECTION CAN BE MADE. AFTER THE PRODUCT IS PURCHASED THE OLD AND NEW CANCEL SWITCHES WILL BE ACTUATED AND THE SALE AND REMOTE CONTROL WILL BE CANCELLED.

IN SOME CASES YOU MAY NOT BE ABLE TO MOUNT THE NEW CANCEL SWITCH ON TOP OF THE EXISTING SWITCH. IF THIS IS THE CASE, REFER TO THE SOLENOID ELECTRICAL INSTALLATION FOR POSSIBLE NEW CANCEL SWITCH LOCATIONS.

## NATIONAL 222/800 WITH ACMR:

THE HIGH PRICE LINKAGE ASSEMBLY IS HELD IN THE UP POSITION BY A HEAVY SPRING AT THE TOP. THIS KEEPS THE VEND LEVER BEHIND THE ACMR, OUT OF THE VEND TRACK OF THE RACTCHET ASSEMBLY ON THE SIDE PANEL.

THE SOLENOID SHOULD OPERATE THIS HIGH PRICE LINKAGE ASSEMBLY. REMOVE HEAVY SPRING FROM THE HIGH PRICE LINKAGE AND LET THE LINKAGE DROP FROM IT'S OWN WEIGHT. THIS ACTION ALLOWS THE VEND LEVER BEHIND THE ACMR TO ENTER AND REMAIN IN THE VEND TRACK UNTIL THE HIGH PRICE LINKAGE IS RAISED UP.

MOUNT THE SOLENOID ABOVE THE LINKAGE SO THAT THE SOLENOID WILL RAISE THE LINKAGE WHEN ENERGIZED.

THE MACHINE WILL NOT VEND PRODUCT UNLESS THE LINKAGE IS IN THE UP POSITION.

## AUTOMATIC PRODUCTS AND ROWE CIGARETTE MACHINES:

SET ALL LINES TO ONE PRICE THEN USE THIS PRICE LINE ONLY.

CUT PRICE LINE AND CONNECT BLACK WIRE TO ONE SIDE AND THE RED WIRE TO THE OTHER.

WITH THIS INSTALLATION THE CUSTOMER CAN INSERT MONEY BUT NOT BE ABLE TO MAKE A SELECTION UNTIL THE REMOTE CONTROL IS ACTUATED.

NEW CANCEL SWITCH IS NEEDED. WE SUGGEST MOUNTING THE CANCEL SWITCH AT APPROXIMATELY 1-2 O'CLOCK ON THE MOTOR CAM.

THIS REMOTE CONTROL UNIT HAS NOTHING TO DO WITH THE MONEY ACCEPTANCE OF THE VENDOR EVEN THOUGH THE UNIT WILL ACCEPT MONEY, PRODUCT CANNOT BE VENDED UNTIL THE REMOTE CONTROL UNIT IS ACTIVATED.

# REMOTE CONTROL UNIT

SERIES HOOKUP FOR  
CURRENCY PARTNER 1000  
OR ANY UNIT WITH A  
VEND SOLENOID

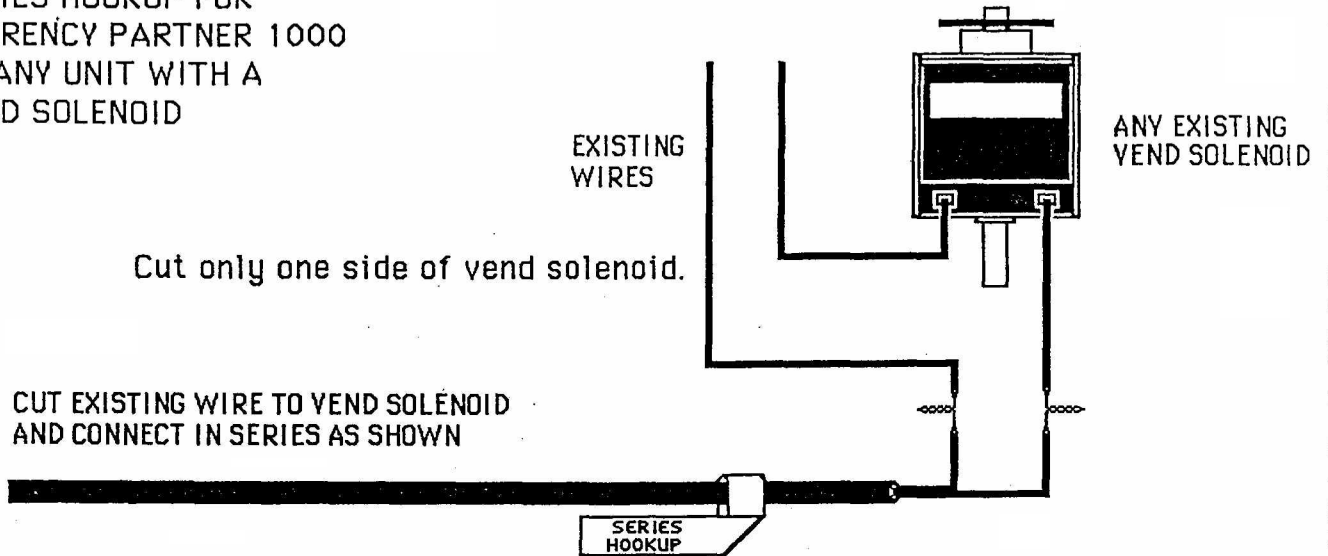

NEW CANCEL SWITCH  
CURRENCY PARTNER 1000

MOUNT ON TOP OF THE EXISTING CANCEL SWITCH



AUTO. PROD. CIGARETTE, ROWE CIGARETTE

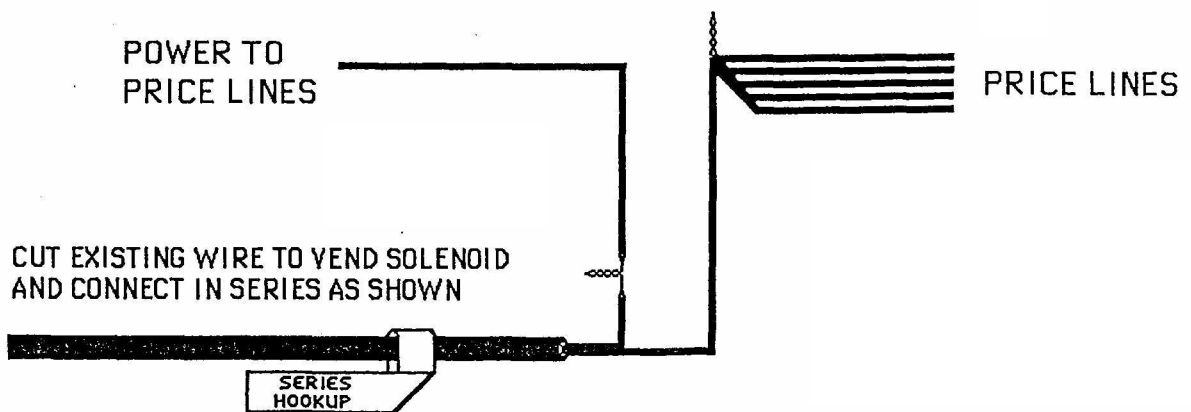

# NATIONAL 222 CIGARETTE VENDOR REMOTE CONTROL FOR UNITS WITH ACMR

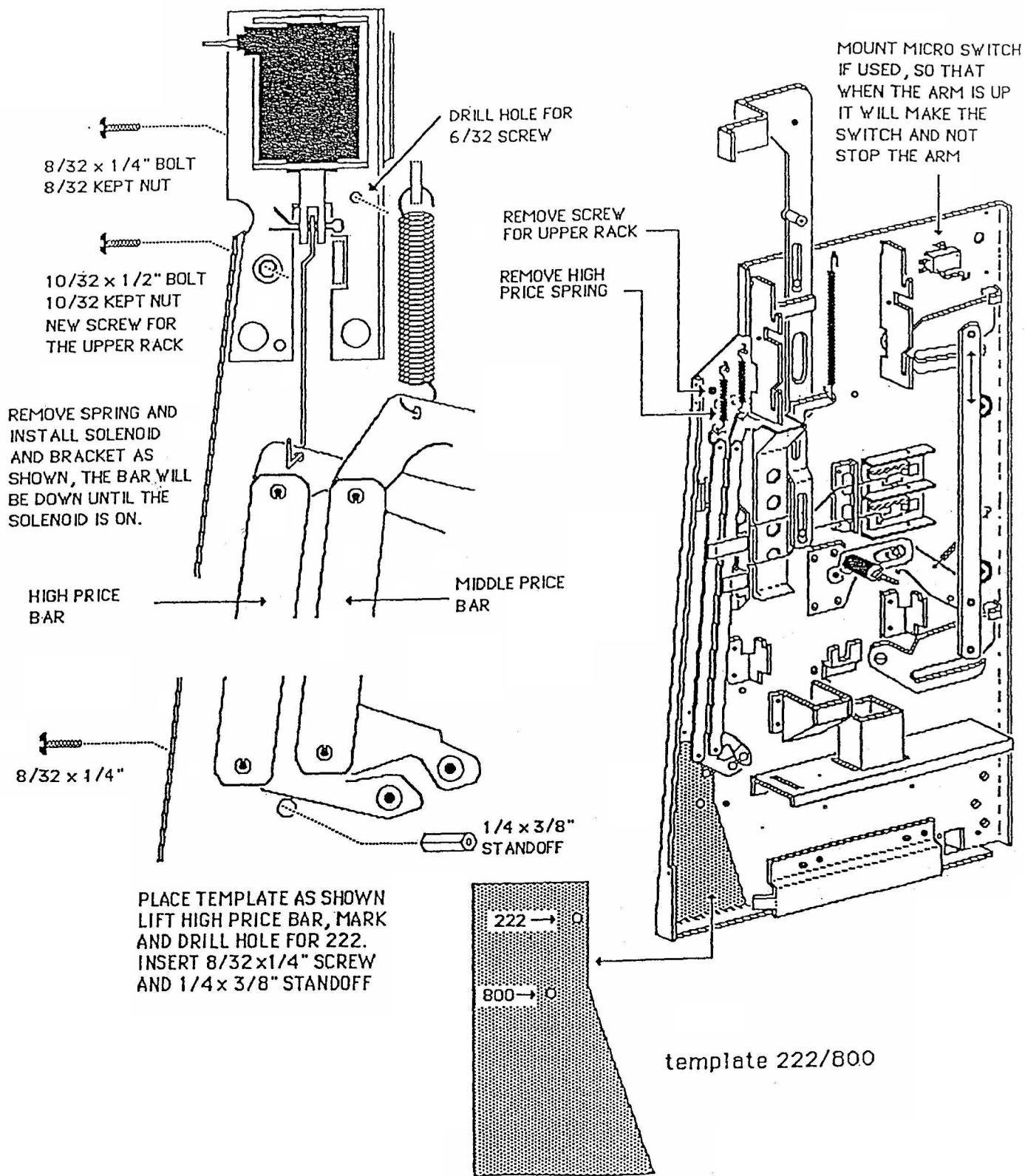

2062 E. 70TH STREET, CLEVELAND, OH 44103  
(216) 361-1022 OR TOLL FREE (800) 445-8363

VENDING, INC.

# REPROGRAMMING RECEIVING UNIT FOR NEW TRANSMITTER

Your remote device comes pre-programmed for the transmitter you received.

Should it become necessary to replace your transmitter,  
Please follow the steps listed below.

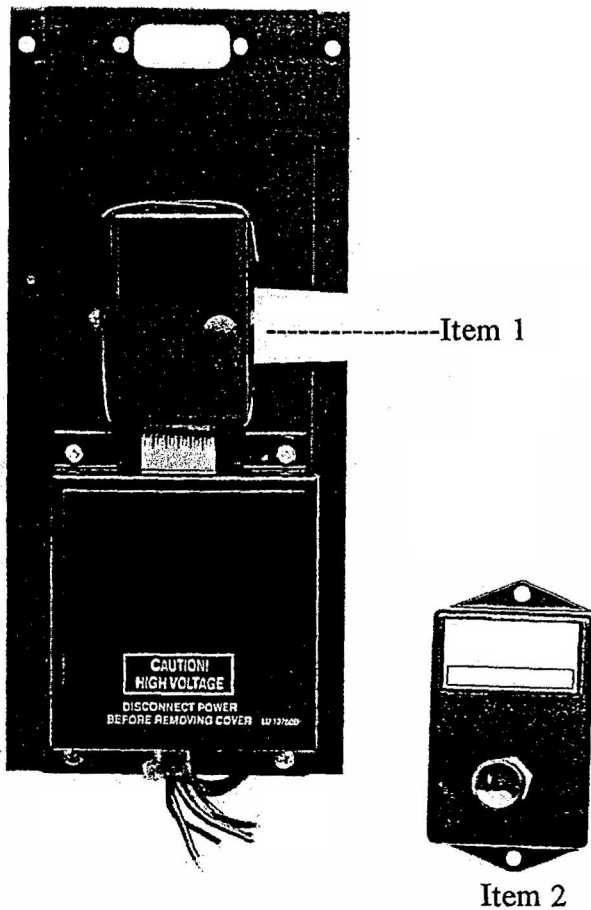

Locate the remote control receiving unit. (shown at left)

Remove black circular plastic plug. (item 1). Under this plug is the reprogramming button.

Hold your transmitter (Item 2) in one hand and depress the button. With this button depressed, depress the reprogramming button on the receiving unit.

Hold them depressed together for approx. 5 seconds.

Your unit is now programmed for the new transmitter.



2062 E. 70TH STREET, CLEVELAND, OH 44103  
(216) 361-1022 OR TOLL FREE (800) 445-8363

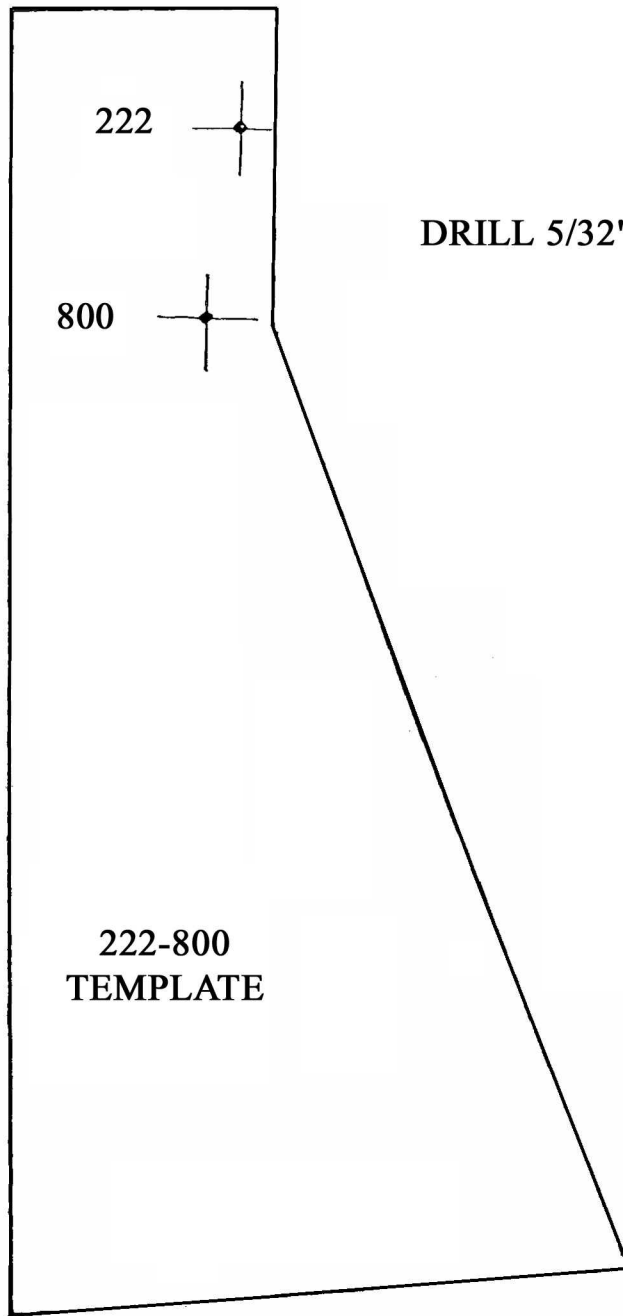

DRILL 5/32" OR 3/16" HOLE

222-800  
TEMPLATE

CUT OUT ON LINE



2062 E. 70TH STREET, CLEVELAND, OH 44103  
(216) 361-1022 OR TOLL FREE (800) 445-8363

VENDING, INC.

# **INSTALLATION SUPPLEMENT**

## **"HARDWIRE" CIGARETTE LOCKOUT DEVICE**

### **PART NUMBER D0151**

THE D0151 UNIT INSTALLS EASILY USING THE SAME INSTRUCTIONS AS THE D0150 WIRELESS REMOTE LOCKOUT DEVICE EXCEPT FOR THE FOLLOWING DIFFERENCE:

YOU SHOULD IGNORE ALL OF THE SECTIONS PERTAINING TO THE TRANSMITTER SINCE YOU WILL BE INSTALLING A WIRED BUTTON TO YOUR UNIT.

WHEN YOU RECEIVED YOUR KIT, YOU RECEIVED A WIRED BUTTON WITH 50' OF CABLE ATTACHED TO IT. PLACE THE BUTTON BOX AT THE DESIRED LOCATION AND ROUTE THE 50' OF CABLE BACK TO THE MACHINE. DRILL A HOLES IN THE CABINET SO THAT YOU CAN RUN THE PLUG INTO THE MACHINE AND ATTACH IT TO THE RECEIVING UNIT. THE INSTALLATION IS NOW COMPLETE.

**SHOULD YOU HAVE ANY FURTHER QUESTIONS  
PLEASE GIVE US A CALL.**



VENDING, INC.

2062 E. 70TH STREET, CLEVELAND, OH 44103  
(216) 361-1022 OR TOLL FREE (800) 445-8363